

# SAM ELEC

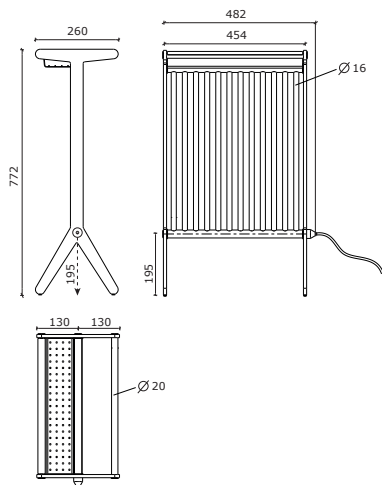

design by Giuseppe Bavuso



CLASSE 1 - CLASS 1



Tappi forniti nei due colori della stoffa scelta  
Caps supplied in the same colors of the chosen fabric  
Bouchons fournis dans les mêmes couleurs du tissu choisi  
Kappen werden in den gleichen Farben des gewählten Stoffes geliefert  
Tapón en los mismos colores de la tela elegida  
Заглушки поставляются в тех же цветах выбранной ткани

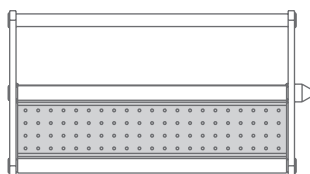

Porta oggetti in alluminio compreso nel prezzo  
Aluminium shelf included in the price  
Porte-objets en aluminium compris dans le prix  
Ablage aus Aluminium im Preis inbegriffen  
Porta-objetos de aluminio incluido en el precio  
Алюминиевая полка включена в цену



**SAM  
combination 1-2-3**  
Aragosta/antracite  
Lobster color/antracite  
Homard / anthracite  
Hummerfarbe / Anthrazit  
Color Langosta / antracita  
Оранжевый красный/антрацит



**SAM  
combination 4-5-6**  
Blu/verde petrolio  
Cobalt blue/ Ocean blue  
Bleu / bleu-vert foncé  
Blau / Petrolgrün  
Azul / verde petróleo  
Синий / темно-сине-зеленый



**SAM  
combination 7-8-9**  
Nero/bianco  
Black/white  
Noir/blanc  
Schwarz / Weiß  
Negro/blanco  
Черный/белый



**SAM  
combination 10-11-12**  
Honey yellow/ Terra brown  
Jaune/marron  
Gelb / Braun  
Amarillo/marrón  
Желтый/коричневый

Stoffa doubleface reversibile idrorepellente.

- tessitura: maglia/jersey
- composizione: 80% PA (Poliammide) e 20% EA (Elastan)
- lavabile a 30 gradi
- NO: Lavaggio a secco
- NO : Asciugatrice
- cavo grigio mt 1,2

Double-sided, reversible, water-repellent fabric.

- Material: jersey
- Composition: 80% PA (polyamide) and 20% EA (elastane)
- Washable at 30°C
- Do not dry clean
- Do not tumble dry
- Grey cable 120 mm

Tissu double face réversible hydrofuge.

- Tissage: maille jersey
- Composition: 80% pa (polyamide) et 20% ea (élasthanne)
- Lavable à 30°C
- Éviter le nettoyage à sec
- Ne pas sécher au sèche-linge
- Câble gris mt 1,2

Reversibler wasserabweisender wendestoff.

- Textur: jersey-masche
- Zusammensetzung: 80% pa (polyamid) und 20% ea (elasthan)
- Waschbar bei 30°
- Nicht chemisch reinigen
- Nicht im trommeltrockner trocknen
- Kabel grau mt 1,2

Tejido de doble cara reversible hidrófugo.

- Tejido: malla jersey
- Composición: 80% pa (poliamida) y 20% ea (elastano)
- Lavable a 30°
- No lavar en seco
- No secar en secadora
- Cable gris mt 1,2

Ткань двусторонняя водоотталкивающая

- Ткань: трикотаж джерси
- состав: 80% полиамид, 20% эластан
- стирка при 30°C
- не стирать в химчистке
- не стирать в стиральной машине
- Серый кабель mt 1,2

codice code code Artikel Nr. codigo код	altezza height hauteur Höhe altura высота	larghezza width largeur Breite ancho ширина	output мощность
	H mm	L mm	watt
<b>SAM combination 1</b>	712	482	150
<b>SAM combination 2</b>	712	482	150
<b>SAM combination 3</b>	712	482	150
<b>SAM combination 4</b>	712	482	150
<b>SAM combination 5</b>	712	482	150
<b>SAM combination 6</b>	712	482	150
<b>SAM combination 7</b>	712	482	150
<b>SAM combination 8</b>	712	482	150
<b>SAM combination 9</b>	712	482	150
<b>SAM combination 10</b>	712	482	150
<b>SAM combination 11</b>	712	482	150
<b>SAM combination 12</b>	712	482	150

**Materiale: acciaio al carbonio + alluminio + stoffa**

**Material: carbon-steel + aluminum + fabric**

**Matériel: acier au carbone + aluminium + tissu**

**Material: Karbonstahl + Aluminium + Stoff**

**Material: acero de carbono + aluminio + tela**

**Материал: углеродистая сталь + алюминий + ткань**

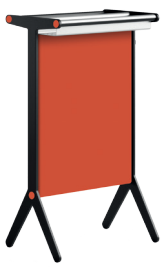

#### SAM combination 1

##### STRUTTURA

Struttura . Structure - Structure - Struktur - Estructura . Структура

nero ruvido opaco / matt rough black/ noir rugueux mat / mattes grobes Schwarz / negro rugoso mate / черный неоднородный

##### STOFFA DOUBLE

Stoffa doubleface . Double-side fabric . Tissu double face . Stoff doppelseitig . Tela doubleface . Двухсторонний материал

RAL 0405070 / 7001 Arancio/grigio . Orange/grey . Orange / gris . Orange / Grau . Naranja / gris . Оранжевый/серый

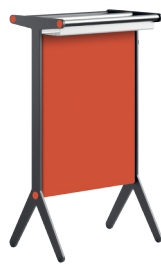

#### SAM combination 2

##### STRUTTURA

Struttura . Structure - Structure - Struktur - Estructura . Структура

RAL 7015 grigio ardesia ruvido opaco/ matt slate rough grey/ gris ardoise rugueux mat/ Schiefergrau matt rau/ gris pizarra rugoso mate / серый грифельный матовый

##### STOFFA DOUBLE

Stoffa doubleface . Double-side fabric . Tissu double face . Stoff doppelseitig . Tela doubleface . Двухсторонний материал

RAL 0405070 / 7001 Arancio/grigio . Orange/grey . Orange / gris . Orange / Grau . Naranja / gris . Оранжевый/серый



#### SAM combination 3

##### STRUTTURA

Struttura . Structure - Structure - Struktur - Estructura . Структура

bianco ruvido opaco / matt rough white/ blanc rugueux mat / mattes grobes Weiß / blanco rugoso mate / белый неоднородный

##### STOFFA DOUBLE

Stoffa doubleface . Double-side fabric . Tissu double face . Stoff doppelseitig . Tela doubleface . Двухсторонний материал

RAL 0405070 / 7001 Arancio/grigio . Orange/grey . Orange / gris . Orange / Grau . Naranja / gris . Оранжевый/серый



#### SAM combination 4

##### STRUTTURA

Struttura . Structure - Structure - Struktur - Estructura . Структура

nero ruvido opaco / matt rough black/ noir rugueux mat / mattes grobes Schwarz / negro rugoso mate / черный неоднородный

##### STOFFA DOUBLE

Stoffa doubleface . Double-side fabric . Tissu double face . Stoff doppelseitig . Tela doubleface . Двухсторонний материал

RAL 5013 / 5020 Blu/verde petrolio . Cobalt blue/ Ocean blue . Bleu / bleu-vert foncé . Blau / Petrolgrün . Azul / verde petróleo . Синий / темно-синие-зеленый



#### SAM combination 5

##### STRUTTURA

Struttura . Structure - Structure - Struktur - Estructura . Структура

RAL 715 grigio ardesia opaco / matt slate grey/ gris ardoise mat / mattes Schiefergrau / gris pizarra mate / серый грифельный матовый

##### STOFFA DOUBLE

stoffa double - stoffa double - stoffa double - stoffa double - stoffa double

RAL 5013 / 5020 Blu/verde petrolio . Cobalt blue/ Ocean blue . Bleu / bleu-vert foncé . Blau / Petrolgrün . Azul / verde petróleo . Синий / темно-синие-зеленый



#### SAM combination 6

##### STRUTTURA

Struttura . Structure - Structure - Struktur - Estructura . Структура

bianco ruvido opaco / matt rough white/ blanc rugueux mat / mattes grobes Weiß / blanco rugoso mate / белый неоднородный

##### STOFFA DOUBLE

stoffa double - stoffa double - stoffa double - stoffa double - stoffa double

RAL 5013 / 5020 Blu/verde petrolio . Cobalt blue/ Ocean blue . Bleu / bleu-vert foncé . Blau / Petrolgrün . Azul / verde petróleo . Синий / темно-синие-зеленый



#### SAM combination 7

##### STRUTTURA

Struttura . Structure - Structure - Struktur - Estructura . Структура

nero ruvido opaco / matt rough black/ noir rugueux mat / mattes grobes Schwarz / negro rugoso mate / черный неоднородный

##### STOFFA DOUBLE

Stoffa doubleface . Double-side fabric . Tissu double face . Stoff doppelseitig . Tela doubleface . Двухсторонний материал

RAL 9005 / 90167 Nero/bianco . Black/ white . Noir/blanc . Schwarz / Weiß . Negro/blanco . Черный/белый



#### SAM combination 8

##### STRUTTURA

Struttura . Structure - Structure - Struktur - Estructura . Структура

RAL 715 grigio ardesia opaco / matt slate grey/ gris ardoise mat / mattes Schiefergrau / gris pizarra mate / серый грифельный матовый

##### STOFFA DOUBLE

Stoffa doubleface . Double-side fabric . Tissu double face . Stoff doppelseitig . Tela doubleface . Двухсторонний материал

RAL 9005 / 90167 Nero/bianco . Black/ white . Noir/blanc . Schwarz / Weiß . Negro/blanco . Черный/белый



#### SAM combination 9

##### STRUTTURA

Struttura . Structure - Structure - Struktur - Estructura . Структура

bianco ruvido opaco / matt rough white/ blanc rugueux mat / mattes grobes Weiß / blanco rugoso mate / белый неоднородный

##### STOFFA DOUBLE

Stoffa doubleface . Double-side fabric . Tissu double face . Stoff doppelseitig . Tela doubleface . Двухсторонний материал

RAL 9005 / 90167 Nero/bianco . Black/ white . Noir/blanc . Schwarz / Weiß . Negro/blanco . Черный/белый

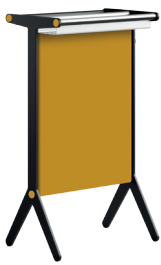

#### SAM combination 10

##### STRUTTURA

Struttura . Structure - Structure - Struktur - Estructura . Структура

nero ruvido opaco / matt rough black/ noir rugueux mat / mattes grobes Schwarz / negro rugoso mate / черный неоднородный

##### STOFFA DOUBLE

Stoffa doubleface . Double-side fabric . Tissu double face . Stoff doppelseitig . Tela doubleface . Двухсторонний материал

RAL 1005 / 8028 Giallo/marrone . Honey yellow/ Terra brown . Jaune/marron . Gelb / Braun . Amarillo/marrón . Желтый/коричневый

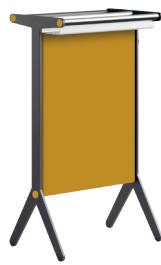

#### SAM combination 11

##### STRUTTURA

Struttura . Structure - Structure - Struktur - Estructura . Структура

RAL 715 grigio ardesia opaco / matt slate grey/ gris ardoise mat / mattes Schiefergrau / gris pizarra mate / серый грифельный матовый

##### STOFFA DOUBLE

Stoffa doubleface . Double-side fabric . Tissu double face . Stoff doppelseitig . Tela doubleface . Двухсторонний материал

RAL 1005 / 8028 Giallo/marrone . Honey yellow/ Terra brown . Jaune/marron . Gelb / Braun . Amarillo/marrón . Желтый/коричневый

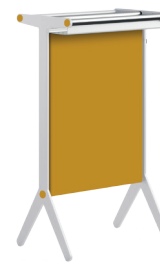

#### SAM combination 12

##### STRUTTURA

Struttura . Structure - Structure - Struktur - Estructura . Структура

bianco ruvido opaco / matt rough white/ blanc rugueux mat / mattes grobes Weiß / blanco rugoso mate / белый неоднородный

##### STOFFA DOUBLE

Stoffa doubleface . Double-side fabric . Tissu double face . Stoff doppelseitig . Tela doubleface . Двухсторонний материал

RAL 1005 / 8028 Giallo/marrone . Honey yellow/ Terra brown . Jaune/marron . Gelb / Braun . Amarillo/marrón . Желтый/коричневый